



BUILDER SERIES 2023 CATALOG





**Kitchen
Cabinet
Distributors™**



Our Vision

We provide thoughtful products and exceptional service to inspire spaces where people love to live.

Table of Contents

Cabinet Line	4
Product Details	6
Product Specifications	7
Wall Cabinets	8
Base Cabinets	9
Tall Cabinets	11
Vanity Cabinets	12
Fillers & Panels	13
Moldings & Trim	14
Accessories	15
Decorative Hardware	17

Essential BUILDER SERIES





Our **NEW Builder Series** satisfies either the traditional or modern design palette with a look to fit any lifestyle, all at an attractive price point.

The Essential line is offered in gray and white and creates solutions for many design needs. Our broad selection of SKU's, moldings and modifications will bring your vision together, affordably. Add your own personal touch with our Perfect Pairings Decorative Hardware to make your spaces, uniquely you.

Bring it all together with our affordable Essential cabinets. Your stylish rooms will be yours and your guests' favorite places for years to come.



Builder Essential White



Builder Essential Gray



		Builder Essential
Cabinet Box	A	1/2", Particleboard, plywood back
Drawer Box	B	5/8" Solid wood, dovetailed
Drawer Slides	C	DTC Under mount, non-soft close
Wood Species	D	MDF door & drawers, rubberwood face frame
Door Hinge	E	DTC soft close
Shelves	F	Adjustable, 3/4" particleboard
Cabinet Exterior Finish	G	Bright White or Gray to match doors
Cabinet Interior Finish	H	Natural melamine
Partial Overlay	I	5-Piece HDF door rails and stiles with MDF center panel, 2-3/4" stiles and rails



Product Specifications

Wall Cabinets - Base Cabinets - Tall Cabinets - Vanity Cabinets
Molding & Trim - Fillers & Panels - Decorative Accessories

Installing a Blind Wall Cabinet

Proper installation ensures that the doors will open and show correct reveal

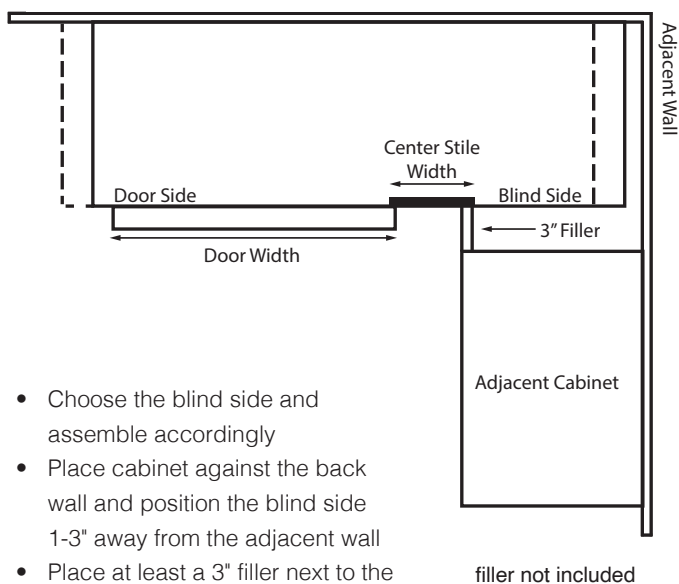

- Choose the blind side and assemble accordingly
- Place cabinet against the back wall and position the blind side 1-3" away from the adjacent wall
- Place at least a 3" filler next to the adjacent cabinet

CREATIVE OPTIONS
FOR ANY SPACE

Wall Cabinet Coding

Standard (12" Deep)

Refrigerator



Notes:

- Standard wall cabinets are 12" deep. Refrigerator cabinets are 24" deep.
- Add door thickness for total cabinet depth.
- Please refer to the Products by Cabinet Line chart to determine which products are carried for each cabinet line.



36" Blind Wall Cabinet

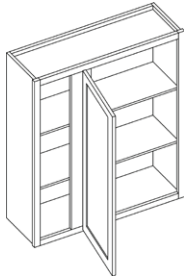

Item Code	Outer Dimensions		
	W	H	D
BW3636	36	15	12
BW3642	42	15	12

*Image shown is left hinge

Corner Wall Cabinet

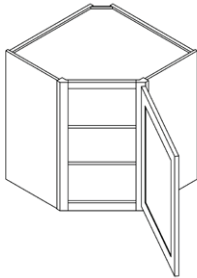

Item Code	Outer Dimensions		
	W	H	D
CW2430	24	30	12
CW2436	24	36	12
CW2442	24	42	12
CW2736	27	36	12
CW2742	27	42	12

24" Deep Wall Cabinet

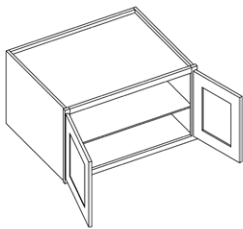

Item Code	Outer Dimensions		
	W	H	D
W361824	36	18	24
W362424	36	24	24

Wine Rack

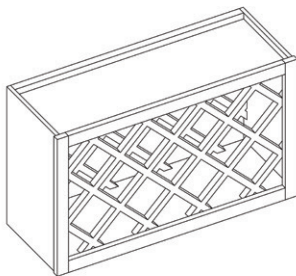

Item Code	Outer Dimensions		
	W	H	D
WR3018	30	18	12

Double Door Wall Cabinet

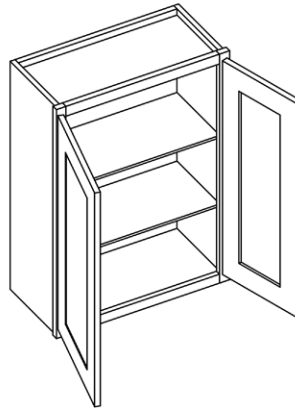

Item Code	Outer Dimensions		
	W	H	D
W2430-2	24	30	12
W2436-2	24	36	12
W2442-2	24	42	12
W2730	27	30	12
W2736	27	36	12
W2742	27	42	12
W3012	30	12	12
W3015	30	15	12
W3018	30	18	12
W3024	30	24	12
W3030	30	30	12
W3036	30	36	12
W3042	30	42	12
W3315	33	15	12
W3330	33	30	12
W3336	33	36	12
W3342	33	42	12
W3612	36	12	12
W3615	36	15	12
W3618	36	18	12
W3624	36	24	12
W3630	36	30	12
W3636	36	36	12
W3642	36	42	12
W3918	39	18	12
W3924	39	24	12

Single Door Wall Cabinet

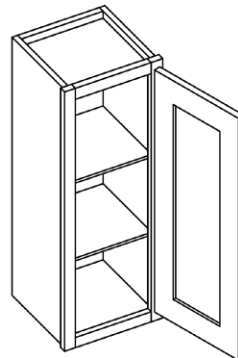

Item Code	Outer Dimensions		
	W	H	D
W1230	12	30	12
W1236	12	36	12
W1242	12	42	12
W1530	15	30	12
W1536	15	36	12
W1542	15	42	12
W1830	18	30	12
W1836	18	36	12
W1842	18	42	12
W2130	21	30	12
W2136	21	36	12
W2142	21	42	12
W930	9	30	12
W936	9	36	12
W942	9	42	12

Base Cabinet Coding

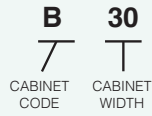

Notes:

- Standard base cabinets are 24" deep and 34.5" high.
- Add door thickness for total cabinet depth.
- Please refer to the Products by Cabinet Line chart to determine which products are carried for each cabinet line.
- Napa White has a single drawer on all sizes.

Single Door Full Height Base Cabinet

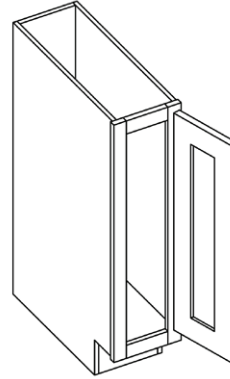

Item Code	Outer Dimensions		
	W	H	D
B09	9	34.5	24

Double Door Standard Base Cabinet

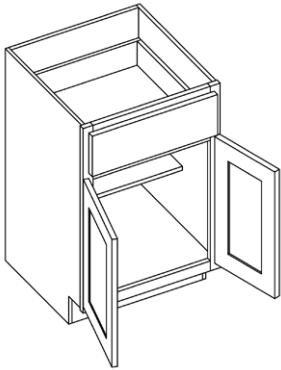

Item Code	Outer Dimensions		
	W	H	D
B24-2	24	34.5	24
B27	27	34.5	24
B30	30	34.5	24
B33	33	34.5	24
B36	36	34.5	24

Single Door Standard Base Cabinet

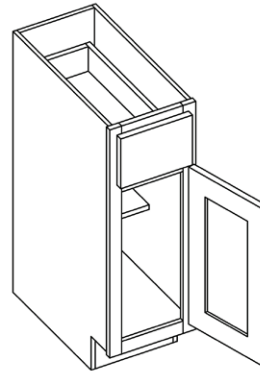

Item Code	Outer Dimensions		
	W	H	D
B12	12	34.5	24
B15	15	34.5	24
B18	18	34.5	24
B21	21	34.5	24

Drawer Base Cabinet

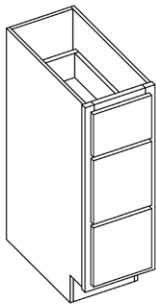

Item Code	Outer Dimensions		
	W	H	D
DB12-3	12	34.5	24
DB15-3	15	34.5	24
DB18-3	18	34.5	24
DB21-3	21	34.5	24
DB24-3	24	34.5	24
DB30-3	30	34.5	24

Sink Base Cabinet

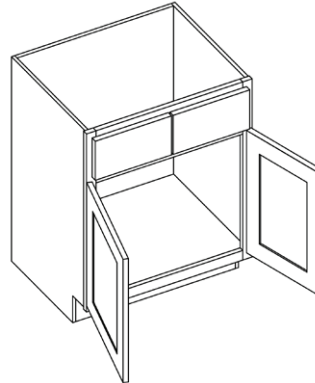

Item Code	Outer Dimensions		
	W	H	D
SB30	30	34.5	24
SB33	33	34.5	24
SB36	36	34.5	24
SB42	42	34.5	24

NATURAL CORNER SINK FRONT FLOOR

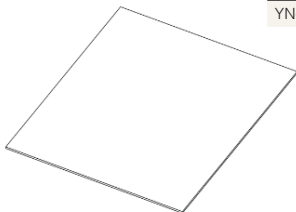

Item Code	Outer Dimensions		
	W	H	D
YN-CSF-FLOOR	48	0.5	48

Corner Sink Front

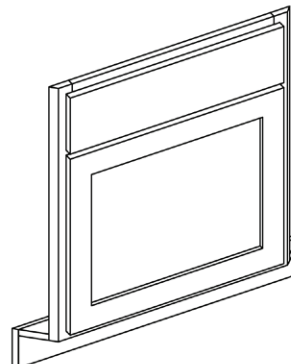

Item Code	Outer Dimensions		
	W	H	D
CSF42	27	42	12

Blind Base Cabinet

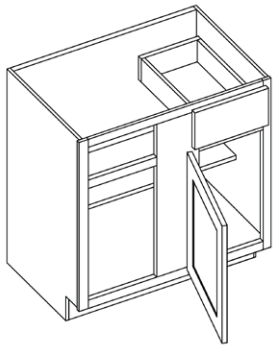

Item Code	Outer Dimensions		
	W	H	D
BB36	36	34.5	24
BB42	42	34.5	24
BB48	48	34.5	24

*Image shown is left hinge

Easy Reach

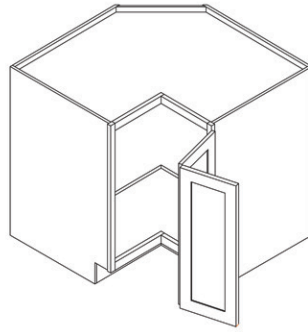

Item Code	Outer Dimensions		
	W	H	D
ER36	36	34.5	24

Installing a Blind Base Cabinet

Proper installation ensures that the drawer will clear hardware, and doors will open, and show correct reveal

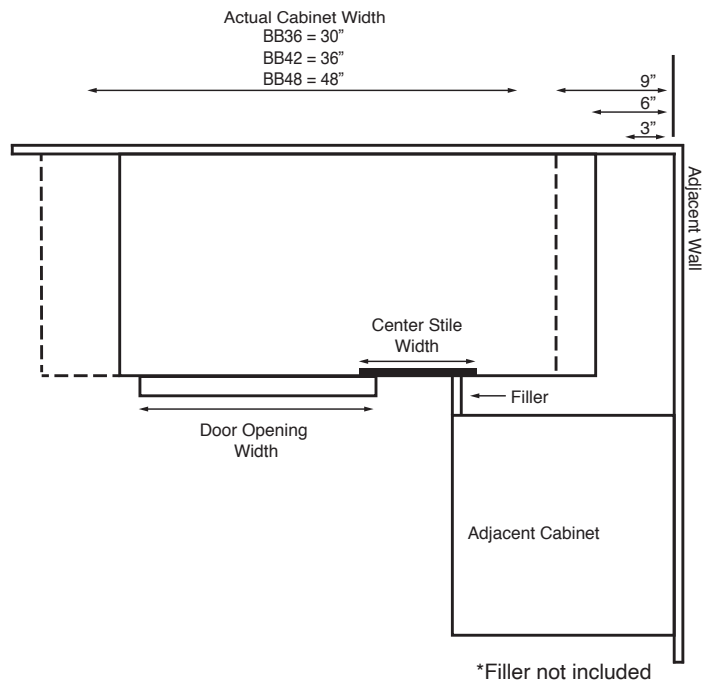

- Place the cabinet back against the back wall
 - BB36 and BB42 – position the blind side 6"-9" away from the adjacent wall
 - BB48 - position the blind side 0"-3" away from the adjacent wall
- Place at least a 3" filler next to adjacent cabinet



Tall Cabinet Coding



Notes:

- Standard tall cabinets are 24" deep.
- Add door thickness for total cabinet depth.
- Please refer to the Products by Cabinet Line chart to determine which products are carried for each cabinet line.

Oven Cabinet

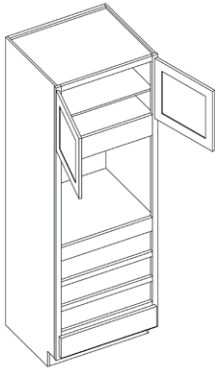

Item Code	Outer Dimensions		
	W	H	D
OC3390	33	90	24
OC3396	33	96	24

Oven Cabinet Drawer

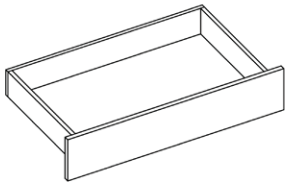

Item Code	Outer Dimensions		
	W	H	D
OCD337	12	6.75	24

Oven Cabinet Overlay Panel

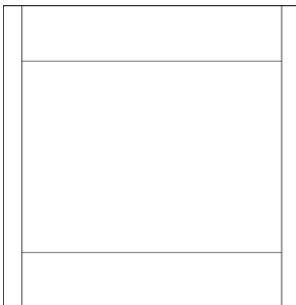

Item Code	Outer Dimensions		
	W	H	D
OP3353	33	53	0.75

Single Door Pantry

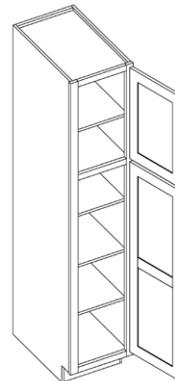

Item Code	Outer Dimensions		
	W	H	D
P1884	18	84	24
P1890	18	90	24
P1896	18	96	24



Vanity Cabinet Coding

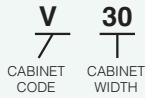

Notes:

- Standard vanity cabinets are 21" deep.
- Add door thickness for total cabinet depth.
- Please refer to the Products by Cabinet Line chart to determine which products are carried for each cabinet line.
- Napa White has a single drawer on all sizes.

Vanity Drawer Base

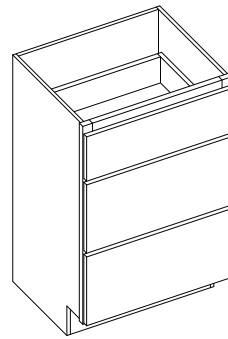

Item Code	Outer Dimensions		
	W	H	D
VDB12	12	34.5	21
VDB15	15	34.5	21
VDB18	18	34.5	21
VDB21	21	34.5	21
VDB24	24	34.5	21

Double Door Vanity

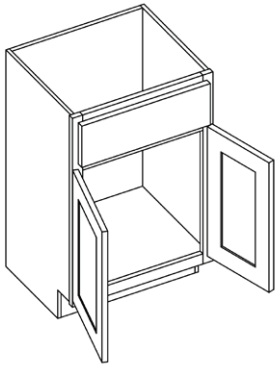

Item Code	Outer Dimensions		
	W	H	D
V24-2	24	34.5	21
V27	27	34.5	21
V30	30	34.5	21
V33	33	34.5	21
V36	36	34.5	21

Vanity Sink Base

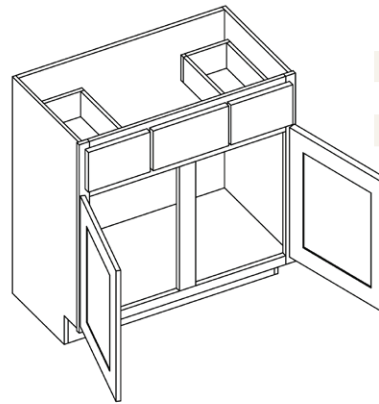

Item Code	Outer Dimensions		
	W	H	D
VSB36	36	34.5	21
VSB42	42	34.5	21
VSB48	48	34.5	21

Single Door Base Vanity

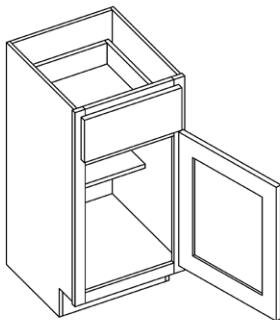

Item Code	Outer Dimensions		
	W	H	D
VB15	15	34.5	21
VB18	18	34.5	21





1/2" Thick Finished Plywood Panel

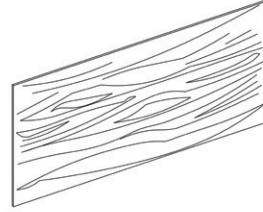

Item Code	Outer Dimensions		
	W	H	D
PSP4896	96	48	0.5

*Finished one side, natural UV back

Back Panel - Long Grain Plywood

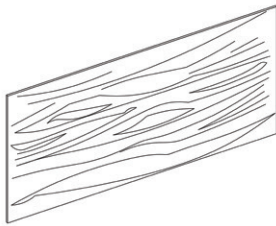

Item Code	Outer Dimensions		
	W	H	D
BPLG4896	48	96	0.25

*Finished one side, raw back

Bead Board

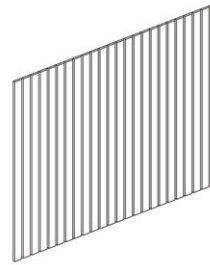

Item Code	Outer Dimensions		
	W	H	D
BBP4842	48	42	0.25

*Finished one side, raw back

Filler



Item Code	Outer Dimensions		
	W	H	D
F396	3	96	0.75
F696	6	96	0.75

*All four edges finished

Overlay Filler



Item Code	Outer Dimensions		
	W	H	D
OLF330	2.5	28.75	0.75
OLF336	2.5	34.75	0.75
OLF342	2.5	40.75	0.75
OLF630	5.5	28.75	0.75

*All four edges finished
NOTE: Sizes do not measure true.

Fluted Filler



Item Code	Outer Dimensions		
	W	H	D
FF396	3	96	0.75

*All four edges finished

Dishwasher End Panel



Item Code	Outer Dimensions		
	W	H	D
DWR3	3	34.5	24

*0.5" panel thickness
*Finished one side, natural UV back

Tall End Panel



Item Code	Outer Dimensions		
	W	H	D
TEP3096	1.5	96	30

*0.5" panel thickness
*Finished one side, natural UV back

Bookcase End



Item Code	Outer Dimensions		
	W	H	D
BCE1596	1.5	96	15

*Requires shelf
*Shelf clips available
*0.5" panel thickness

Shelf



Item Code	Outer Dimensions		
	W	H	D
**SHELF1296	96	0.625	12
***SHELF2496	96	0.625	24

*3/4" plywood construction
**Available in natural or painted
***Available in natural only

Toe Kick - TKS8

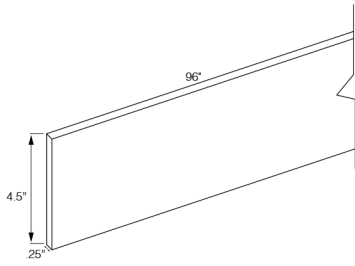

Large Crown Molding - BCM8

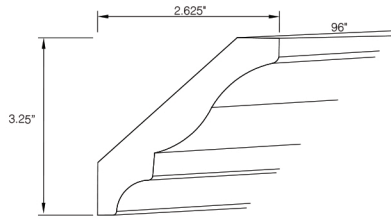

Outside Corner Molding - OCM8

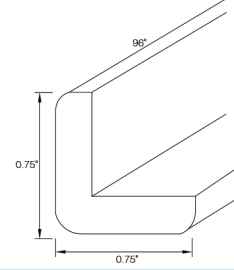

Scribe - SCRIBE

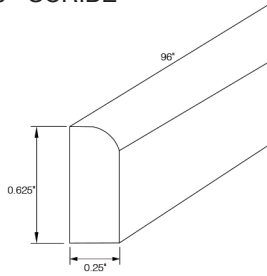

Royal Crown Molding - RCM8

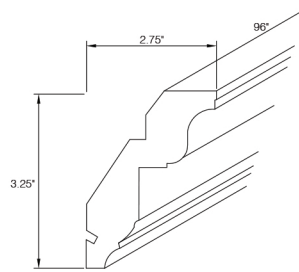

Traditional Light Rail Molding - LRM8

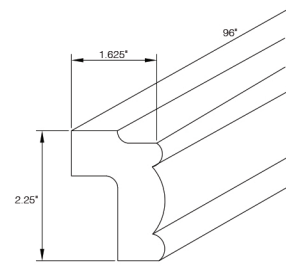

Shoe - SHOE

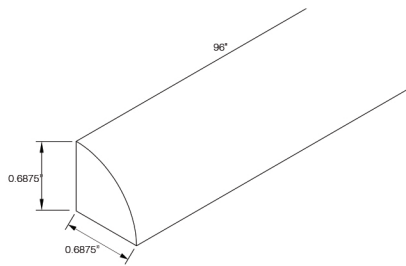

Shaker Crown Molding - SCM8

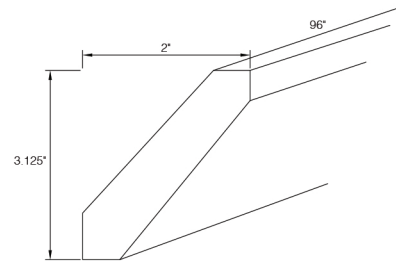

Bottom Edge Molding - BEM8

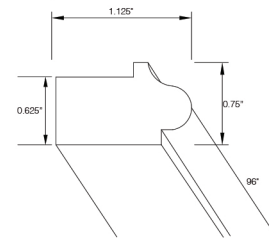

Furniture Base Molding - FBM8

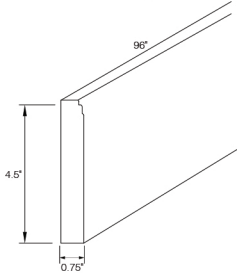

Cove Crown Molding - COM8

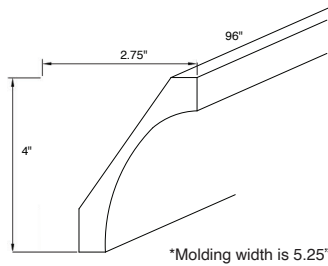

Traditional Crown Molding - CM8

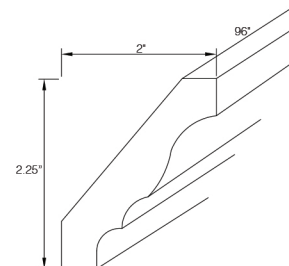

Batten Molding - BAM8

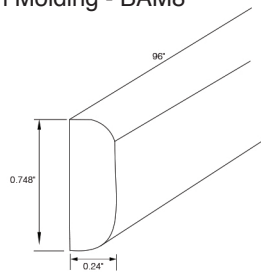

Soft Close Roll Out Tray

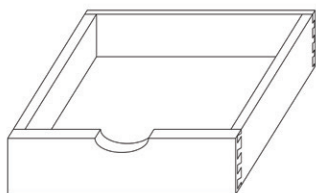

*Includes two trays & four tracks

Item Code	Outer Dimensions		
	W	H	D
YN-ROT15-SC	10.125	4	21
YN-ROT18-SC	13.125	4	21
YN-ROT21-SC	16.125	4	21
YN-ROT24-SC	19.125	4	21
YN-ROT27-SC	22.125	4	21
YN-ROT30-SC	25.125	4	21
YN-ROT33-SC	28.125	4	21
YN-ROT36-SC	31.125	4	21

Roll Out Tray Usage Guide

Item Code	Designed to Fit
ROT15-SC	B15
ROT18-SC	B18, P1884, P1890, P1896
ROT21-SC	B21
ROT24-SC	B24, P2496
ROT27-SC	B27
ROT30-SC	B30, SB30
ROT33-SC	B33, SB33
ROT36-SC	B36, SB36

Lazy Susan Kit

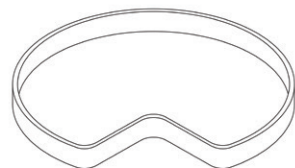

Item Code	Outer Dimensions		
	W	H	D
YN-LSK	29	1.5	29

*Includes two trays for shelf mounting
*Birch plywood construction

Spice Rack Door Attachment

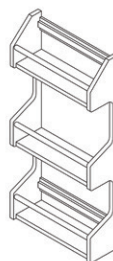

Item Code	Outer Dimensions		
	W	H	D
YN-SRD12	11.5	24	4
YN-SRD15	14.5	24	4

Trash Can Insert for B18

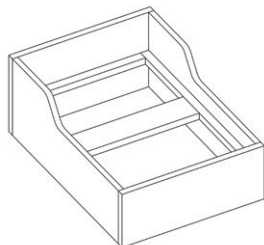

Item Code	Outer Dimensions		
	W	H	D
YN-TCCK*	14.625	4.125	19.75

- Dovetail, solid wood construction
 - Undermount, full extension, soft close slides
- *Includes two 35 QT cans

Spice Tray Insert

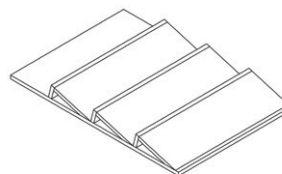

Item Code	Outer Dimensions		
	W	H	D
YN-STI14	13.375	1.094	19.75
YN-STI20	19.75	1.094	19.75

Spice Rack Insert

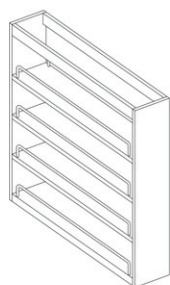

Item Code	Outer Dimensions		
	W	H	D
YN-SRI9-SC	5.75	24	20.5

*Fits in the B09

Stemware Rack

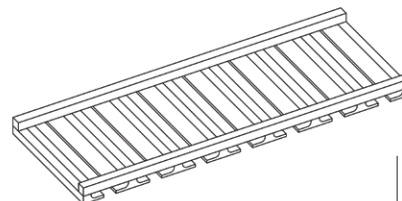

Item Code	Outer Dimensions		
	W	H	D
SWR3012	28.5	1.5	10.5

Cutlery Drawer Insert

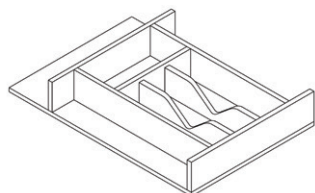

Item Code	Outer Dimensions		
	W	H	D
YN-CDI14	13.375	2.87	19.75
YN-CDI20	19.75	2.87	19.75

*Accessories displayed on this page can be installed on assembled orders

Corbel - Basic Medium

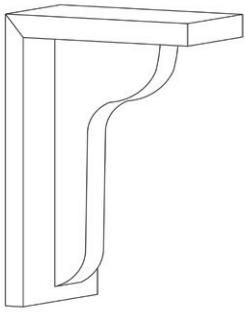

Item Code	Outer Dimensions		
	W	H	D
CORSM	3	10.5	7.5

Corbel - Transitional

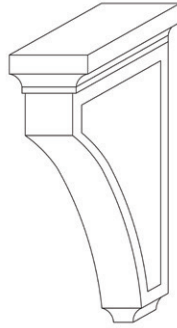

Item Code	Outer Dimensions		
	W	H	D
CORT	3.5	10.5	7

Turned Post

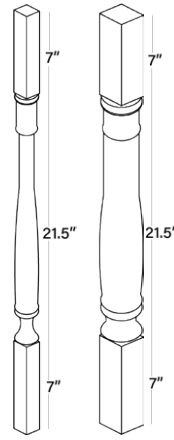

Item Code	Outer Dimensions		
	W	H	D
TPOSTP3	3	35.5	3
TPOSTP5	5	35.5	5

Bunfoot - Transitional

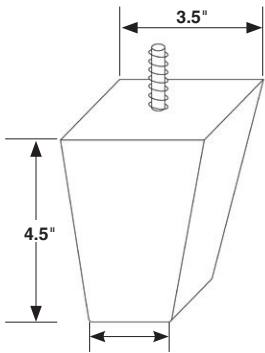

Item Code	Outer Dimensions		
	H	Top	Bottom
TBUNFOOT2	4.5	3.5	2

Bunfoot

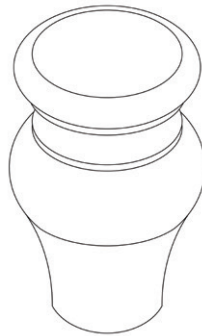

Item Code	Outer Dimensions		
	W	H	D
TBUNFOOT	3	4.5	3



Miscellaneous Parts, Samples & Sales Tools

Item Code	Item Description
Miscellaneous Parts	
SPRAYCAN	Spray Can
TUKIT	Touchup Kit
Mini Base15	Mini Base Sample
YN-PAB	Plastic Assembly Blocks (100/pkg)
YN-BUMPER	Clear bumpers (50/sheet)
YN-SHELF CLIP	Shelf Clip
YN-SOFTCLOSE	Soft Close Hinge
YN-ERHINGE-SET	Easy Reach Hinges - Includes 2 frame-to-door & 2 door-to-door hinges
YN-SOFTCLOSE-CW	Soft Close Corner Wall Hinge

Item Code	Item Description
Samples & Sales Tools	
Sample Doors	Sample Door Set - Includes 15"X15" Sample of Each Door
Sample B15 Door Front Set	Sample B15 Door Front Set - Includes All B15 Fronts
SAMPLE MOLDING SET	Sample Molding Set - Includes Sample of All Molding Types
SAMPLE	Sample Door - 15" W x 15" H
SAMPLEB15	B15 Sample Door, Drawer Front & Face Frame

PERFECT
P
PAIRINGS

We have hand-selected a collection of decorative hardware that compliments the Essential line, so find your Perfect Pairings today!



Discover The Perfect Pairing

Over 200+ Options

kcdus.com/hardware



Introducing KCD's Decorative Hardware Collection, designed to provide the perfect complement to our cabinet door styles. The expansive assortment of possibilities will make it easy to find the perfect pair.



Available Finishes



Rose Gold



Satin Nickel



Matte Black



Polished Chrome



Dark Pewter



Brushed Bronze



Appliance Pulls



KCD's Decorative Appliance Collection is designed to provide the perfect complement to our cabinet door hardware.

Miami Appliance Pull
Shown In Matte Black



Charlotte Appliance Pull
Shown In Rose Gold



Manhattan Appliance Pull
Shown In Satin Nickel



Colorado Appliance Pull
Shown In Matte Black



Vail Appliance Pull
Shown In Rose Gold



Modern Square Appliance Pull
Shown In Satin Nickel



Monaco Appliance Pull
Shown In Matte Black



Milan Appliance Pull
Shown In Rose Gold



It's smart to match your hardware FINISH throughout the kitchen. This choice creates a coordinated look even when your knobs and handles are different.

Available Finishes



Rose Gold



Satin Nickel



Matte Black





Floating Shelves



Decorative Hardware Collection offers Floating Shelves for accents to add beauty and function to your kitchen or bathroom.

Choose from three finishes and five different size options with our Floating Shelves. Create the clutter free look giving you the perfect balance of spontaneity and class.



White Oak

Available Finishes



White Oak



Walnut



Maple



Walnut

Available Widths

12", 24", 30", 36", 42"



Maple

Brackets



Brackets (2/pkg) included with all floating shelves.

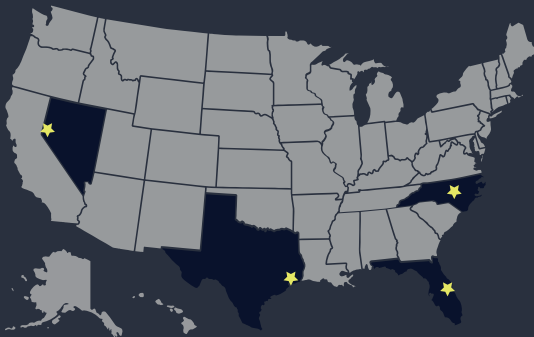

RALEIGH

2114 ATLANTIC AVE.
SUITE 106
RALEIGH, NC 27604

RENO

9585 N VIRGINIA ST.
SUITE 100
RENO, NV 89506

HOUSTON

600 FALLBROOK DR.
SUITE 100
HOUSTON, TX 77038

ORLANDO

650 HERMIT SMITH RD.
SUITE 100
APOPKA, FL 32703

(833) 229-0009 KCDUS.COM

